

PEARSON NEW INTERNATIONAL EDITION

Computer Graphics with Open GL
Hearn Baker Carithers
Fourth Edition



Pearson New International Edition

Computer Graphics with Open GL
Hearn Baker Carithers
Fourth Edition

PEARSON

Pearson Education Limited

Edinburgh Gate

Harlow

Essex CM20 2JE

England and Associated Companies throughout the world

Visit us on the World Wide Web at: www.pearsoned.co.uk

© Pearson Education Limited 2014

All rights reserved. No part of this publication may be reproduced, stored in a retrieval system, or transmitted in any form or by any means, electronic, mechanical, photocopying, recording or otherwise, without either the prior written permission of the publisher or a licence permitting restricted copying in the United Kingdom issued by the Copyright Licensing Agency Ltd, Saffron House, 6–10 Kirby Street, London EC1N 8TS.

All trademarks used herein are the property of their respective owners. The use of any trademark in this text does not vest in the author or publisher any trademark ownership rights in such trademarks, nor does the use of such trademarks imply any affiliation with or endorsement of this book by such owners.

PEARSON

ISBN 10: 1-292-02425-9

ISBN 13: 978-1-292-02425-7

British Library Cataloguing-in-Publication Data

A catalogue record for this book is available from the British Library

Printed in the United States of America

Table of Contents

1. Computer Graphics Hardware	1
Donald D. Hearn/M. Pauline Baker, Warren Carithers	
Computer Graphics Hardware Color Plates	
Donald D. Hearn/M. Pauline Baker, Warren Carithers	27
2. Computer Graphics Software	
Donald D. Hearn/M. Pauline Baker, Warren Carithers	29
3. Graphics Output Primitives	
Donald D. Hearn/M. Pauline Baker, Warren Carithers	45
4. Attributes of Graphics Primitives	
Donald D. Hearn/M. Pauline Baker, Warren Carithers	99
5. Implementation Algorithms for Graphics Primitives and Attributes	
Donald D. Hearn/M. Pauline Baker, Warren Carithers	131
6. Two-Dimensional Geometric Transformations	
Donald D. Hearn/M. Pauline Baker, Warren Carithers	189
7. Two-Dimensional Viewing	
Donald D. Hearn/M. Pauline Baker, Warren Carithers	227
8. Three-Dimensional Geometric Transformations	
Donald D. Hearn/M. Pauline Baker, Warren Carithers	273
9. Three-Dimensional Viewing	
Donald D. Hearn/M. Pauline Baker, Warren Carithers	301
Three-Dimensional Viewing Color Plate	
Donald D. Hearn/M. Pauline Baker, Warren Carithers	353
10. Hierarchical Modeling	
Donald D. Hearn/M. Pauline Baker, Warren Carithers	355
11. Computer Animation	
Donald D. Hearn/M. Pauline Baker, Warren Carithers	365

12. Three-Dimensional Object Representations	389
Donald D. Hearn/M. Pauline Baker, Warren Carithers	
Three-Dimensional Object Representations Color Plate	407
Donald D. Hearn/M. Pauline Baker, Warren Carithers	
13. Spline Representations	409
Donald D. Hearn/M. Pauline Baker, Warren Carithers	
14. Visible-Surface Detection Methods	465
Donald D. Hearn/M. Pauline Baker, Warren Carithers	
15. Illumination Models and Surface-Rendering Methods	493
Donald D. Hearn/M. Pauline Baker, Warren Carithers	
Illumination Models and Surface-Rendering Methods Color Plates	541
Donald D. Hearn/M. Pauline Baker, Warren Carithers	
16. Texturing and Surface-Detail Methods	543
Donald D. Hearn/M. Pauline Baker, Warren Carithers	
Texturing and Surface-Detail Methods Color Plates	567
Donald D. Hearn/M. Pauline Baker, Warren Carithers	
17. Color Models and Color Applications	569
Donald D. Hearn/M. Pauline Baker, Warren Carithers	
Color Models and Color Applications Color Plate	589
Donald D. Hearn/M. Pauline Baker, Warren Carithers	
18. Interactive Input Methods and Graphical User Interfaces	591
Donald D. Hearn/M. Pauline Baker, Warren Carithers	
Interactive Input Methods and Graphical User Interfaces Color Plates	631
Donald D. Hearn/M. Pauline Baker, Warren Carithers	
19. Global Illumination	633
Donald D. Hearn/M. Pauline Baker, Warren Carithers	
Global Illumination Color Plates	659
Donald D. Hearn/M. Pauline Baker, Warren Carithers	
20. Programmable Shaders	663
Donald D. Hearn/M. Pauline Baker, Warren Carithers	
Programmable Shaders Color Plates	693
Donald D. Hearn/M. Pauline Baker, Warren Carithers	
21. Algorithmic Modeling	695
Donald D. Hearn/M. Pauline Baker, Warren Carithers	
Algorithmic Modeling Color Plates	725
Donald D. Hearn/M. Pauline Baker, Warren Carithers	

22. Visualization of Data Sets	
Donald D. Hearn/M. Pauline Baker, Warren Carithers	729
Visualization of Data Sets Color Plates	
Donald D. Hearn/M. Pauline Baker, Warren Carithers	735
Appendix: Mathematics for Computer Graphics	
Donald D. Hearn/M. Pauline Baker, Warren Carithers	737
Appendix: Graphics File Formats	
Donald D. Hearn/M. Pauline Baker, Warren Carithers	773
Bibliography	
Donald D. Hearn/M. Pauline Baker, Warren Carithers	789
Index	801

This page intentionally left blank

Computer Graphics Hardware

- 1 Video Display Devices
- 2 Raster-Scan Systems
- 3 Graphics Workstations and Viewing Systems
- 4 Input Devices
- 5 Hard-Copy Devices
- 6 Graphics Networks
- 7 Graphics on the Internet
- 8 Summary

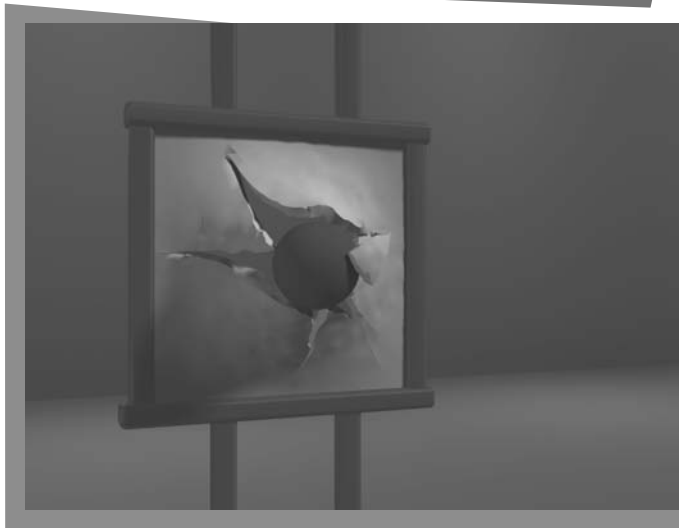

The power and utility of computer graphics is widely recognized, and a broad range of graphics hardware and software systems is now available for applications in virtually all fields. Graphics capabilities for both two-dimensional and three-dimensional applications are now common, even on general-purpose computers and handheld calculators. With personal computers, we can use a variety of interactive input devices and graphics software packages. For higher-quality applications, we can choose from a number of sophisticated special-purpose graphics hardware systems and technologies. In this chapter, we explore the basic features of graphics hardware components and graphics software packages.

1 Video Display Devices

Typically, the primary output device in a graphics system is a video monitor. Historically, the operation of most video monitors was based on the standard **cathode-ray tube (CRT)** design, but several other technologies exist. In recent years, **flat-panel** displays have become significantly more popular due to their reduced power consumption and thinner designs.

Refresh Cathode-Ray Tubes

Figure 1 illustrates the basic operation of a CRT. A beam of electrons (*cathode rays*), emitted by an electron gun, passes through focusing and deflection systems that direct the beam toward specified positions on the phosphor-coated screen. The phosphor then emits a small spot of light at each position contacted by the electron beam. Because the light emitted by the phosphor fades very rapidly, some method is needed for maintaining the screen picture. One way to do this is to store the picture information as a charge distribution within the CRT. This charge distribution can then be used to keep the phosphors activated. However, the most common method now employed for maintaining phosphor glow is to redraw the picture repeatedly by quickly directing the electron beam back over the same screen points. This type of display is called a **refresh CRT**, and the frequency at which a picture is redrawn on the screen is referred to as the **refresh rate**.

The primary components of an electron gun in a CRT are the heated metal cathode and a control grid (Fig. 2). Heat is supplied to the cathode by directing a current through a coil of wire, called the filament, inside the cylindrical cathode structure. This causes electrons to be “boiled off” the hot cathode surface. In

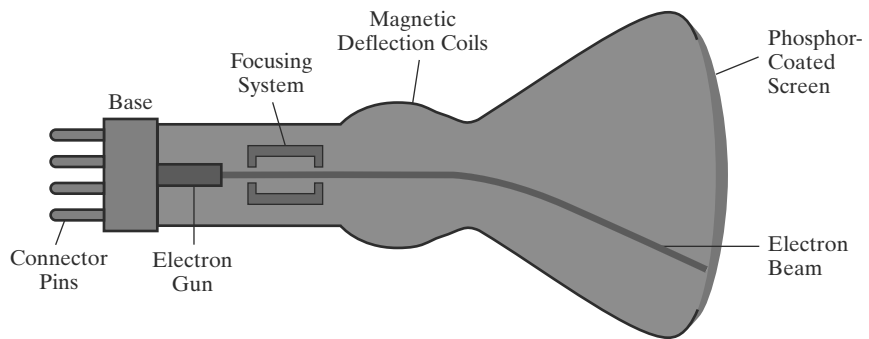

FIGURE 1
Basic design of a magnetic-deflection CRT.

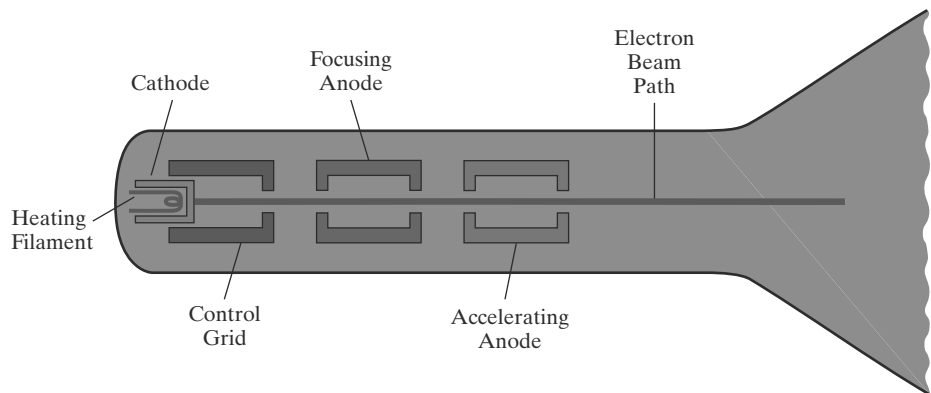

FIGURE 2
Operation of an electron gun with an accelerating anode.

the vacuum inside the CRT envelope, the free, negatively charged electrons are then accelerated toward the phosphor coating by a high positive voltage. The accelerating voltage can be generated with a positively charged metal coating on the inside of the CRT envelope near the phosphor screen, or an accelerating anode, as in Figure 2, can be used to provide the positive voltage. Sometimes the electron gun is designed so that the accelerating anode and focusing system are within the same unit.

Intensity of the electron beam is controlled by the voltage at the control grid, which is a metal cylinder that fits over the cathode. A high negative voltage applied to the control grid will shut off the beam by repelling electrons and stopping them from passing through the small hole at the end of the control-grid structure. A smaller negative voltage on the control grid simply decreases the number of electrons passing through. Since the amount of light emitted by the phosphor coating depends on the number of electrons striking the screen, the brightness of a display point is controlled by varying the voltage on the control grid. This brightness, or intensity level, is specified for individual screen positions with graphics software commands.

The focusing system in a CRT forces the electron beam to converge to a small cross section as it strikes the phosphor. Otherwise, the electrons would repel each other, and the beam would spread out as it approaches the screen. Focusing is accomplished with either electric or magnetic fields. With electrostatic focusing, the electron beam is passed through a positively charged metal cylinder so that electrons along the center line of the cylinder are in an equilibrium position. This arrangement forms an electrostatic lens, as shown in Figure 2, and the electron beam is focused at the center of the screen in the same way that an optical lens focuses a beam of light at a particular focal distance. Similar lens focusing effects can be accomplished with a magnetic field set up by a coil mounted around the outside of the CRT envelope, and magnetic lens focusing usually produces the smallest spot size on the screen.

Additional focusing hardware is used in high-precision systems to keep the beam in focus at all screen positions. The distance that the electron beam must travel to different points on the screen varies because the radius of curvature for most CRTs is greater than the distance from the focusing system to the screen center. Therefore, the electron beam will be focused properly only at the center of the screen. As the beam moves to the outer edges of the screen, displayed images become blurred. To compensate for this, the system can adjust the focusing according to the screen position of the beam.

As with focusing, deflection of the electron beam can be controlled with either electric or magnetic fields. Cathode-ray tubes are now commonly constructed with magnetic-deflection coils mounted on the outside of the CRT envelope, as illustrated in Figure 1. Two pairs of coils are used for this purpose. One pair is mounted on the top and bottom of the CRT neck, and the other pair is mounted on opposite sides of the neck. The magnetic field produced by each pair of coils results in a transverse deflection force that is perpendicular to both the direction of the magnetic field and the direction of travel of the electron beam. Horizontal deflection is accomplished with one pair of coils, and vertical deflection with the other pair. The proper deflection amounts are attained by adjusting the current through the coils. When electrostatic deflection is used, two pairs of parallel plates are mounted inside the CRT envelope. One pair of plates is mounted horizontally to control vertical deflection, and the other pair is mounted vertically to control horizontal deflection (Fig. 3).

Spots of light are produced on the screen by the transfer of the CRT beam energy to the phosphor. When the electrons in the beam collide with the phosphor

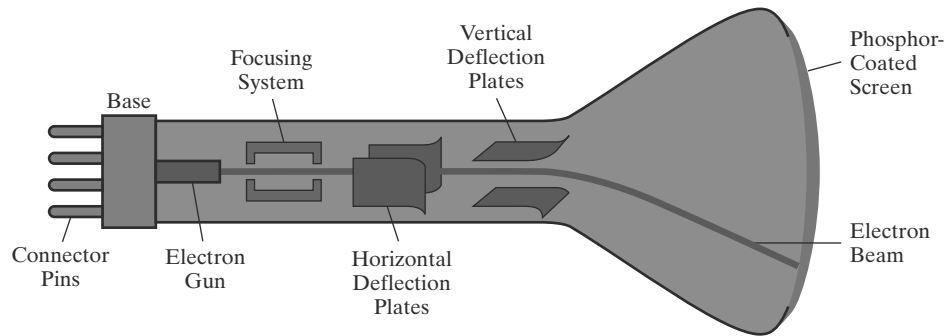

FIGURE 3
Electrostatic deflection of the electron beam in a CRT.

coating, they are stopped and their kinetic energy is absorbed by the phosphor. Part of the beam energy is converted by friction into heat energy, and the remainder causes electrons in the phosphor atoms to move up to higher quantum-energy levels. After a short time, the “excited” phosphor electrons begin dropping back to their stable ground state, giving up their extra energy as small quanta of light energy called photons. What we see on the screen is the combined effect of all the electron light emissions: a glowing spot that quickly fades after all the excited phosphor electrons have returned to their ground energy level. The frequency (or color) of the light emitted by the phosphor is in proportion to the energy difference between the excited quantum state and the ground state.

Different kinds of phosphors are available for use in CRTs. Besides color, a major difference between phosphors is their **persistence**: how long they continue to emit light (that is, how long it is before all excited electrons have returned to the ground state) after the CRT beam is removed. Persistence is defined as the time that it takes the emitted light from the screen to decay to one-tenth of its original intensity. Lower-persistence phosphors require higher refresh rates to maintain a picture on the screen without flicker. A phosphor with low persistence can be useful for animation, while high-persistence phosphors are better suited for displaying highly complex, static pictures. Although some phosphors have persistence values greater than 1 second, general-purpose graphics monitors are usually constructed with persistence in the range from 10 to 60 microseconds.

Figure 4 shows the intensity distribution of a spot on the screen. The intensity is greatest at the center of the spot, and it decreases with a Gaussian distribution out to the edges of the spot. This distribution corresponds to the cross-sectional electron density distribution of the CRT beam.

The maximum number of points that can be displayed without overlap on a CRT is referred to as the **resolution**. A more precise definition of resolution is the number of points per centimeter that can be plotted horizontally and vertically, although it is often simply stated as the total number of points in each direction. Spot intensity has a Gaussian distribution (Fig. 4), so two adjacent spots will appear distinct as long as their separation is greater than the diameter at which each spot has an intensity of about 60 percent of that at the center of the spot. This overlap position is illustrated in Figure 5. Spot size also depends on intensity. As more electrons are accelerated toward the phosphor per second, the diameters of the CRT beam and the illuminated spot increase. In addition, the increased excitation energy tends to spread to neighboring phosphor atoms not directly in the path of the beam, which further increases the spot diameter. Thus, resolution of a CRT is dependent on the type of phosphor, the intensity to be displayed, and the focusing and deflection systems. Typical resolution on high-quality systems is 1280 by 1024, with higher resolutions available on many systems. High-resolution systems are often referred to as *high-definition systems*.

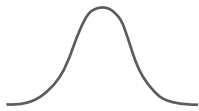

FIGURE 4
Intensity distribution of an illuminated phosphor spot on a CRT screen.

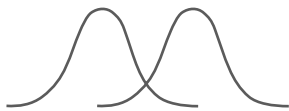

FIGURE 5
Two illuminated phosphor spots are distinguishable when their separation is greater than the diameter at which a spot intensity has fallen to 60 percent of maximum.

The physical size of a graphics monitor, on the other hand, is given as the length of the screen diagonal, with sizes varying from about 12 inches to 27 inches or more. A CRT monitor can be attached to a variety of computer systems, so the number of screen points that can actually be plotted also depends on the capabilities of the system to which it is attached.

Raster-Scan Displays

The most common type of graphics monitor employing a CRT is the **raster-scan display**, based on television technology. In a raster-scan system, the electron beam is swept across the screen, one row at a time, from top to bottom. Each row is referred to as a **scan line**. As the electron beam moves across a scan line, the beam intensity is turned on and off (or set to some intermediate value) to create a pattern of illuminated spots. Picture definition is stored in a memory area called the **refresh buffer** or **frame buffer**, where the term **frame** refers to the total screen area. This memory area holds the set of color values for the screen points. These stored color values are then retrieved from the refresh buffer and used to control the intensity of the electron beam as it moves from spot to spot across the screen. In this way, the picture is “painted” on the screen one scan line at a time, as demonstrated in Figure 6. Each screen spot that can be illuminated by the electron beam is referred to as a **pixel** or **pel** (shortened forms of **picture element**). Since the refresh buffer is used to store the set of screen color values, it is also sometimes called a **color buffer**. Also, other kinds of pixel information, besides color, are stored in buffer locations, so all the different buffer areas are sometimes referred to collectively as the “frame buffer.” The capability of a raster-scan system to store color information for each screen point makes it well suited for the realistic display of scenes containing subtle shading and color patterns. Home television sets and printers are examples of other systems using raster-scan methods.

Raster systems are commonly characterized by their resolution, which is the number of pixel positions that can be plotted. Another property of video monitors

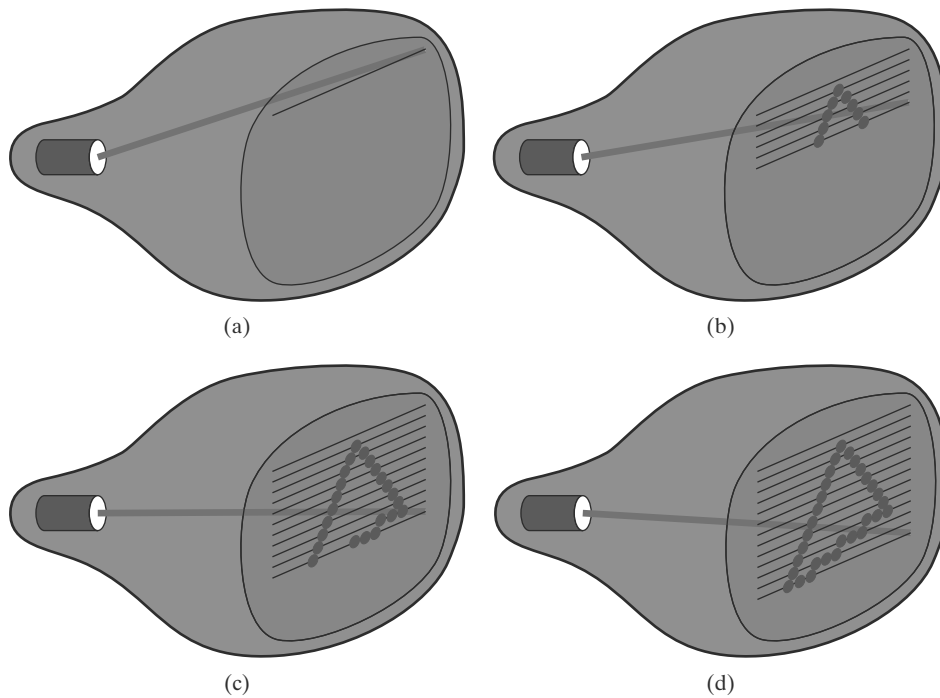

FIGURE 6
A raster-scan system displays an object as a set of discrete points across each scan line.

is **aspect ratio**, which is now often defined as the number of pixel columns divided by the number of scan lines that can be displayed by the system. (Sometimes this term is used to refer to the number of scan lines divided by the number of pixel columns.) Aspect ratio can also be described as the number of horizontal points to vertical points (or vice versa) necessary to produce equal-length lines in both directions on the screen. Thus, an aspect ratio of 4/3, for example, means that a horizontal line plotted with four points has the same length as a vertical line plotted with three points, where line length is measured in some physical units such as centimeters. Similarly, the aspect ratio of any rectangle (including the total screen area) can be defined to be the width of the rectangle divided by its height.

The range of colors or shades of gray that can be displayed on a raster system depends on both the types of phosphor used in the CRT and the number of bits per pixel available in the frame buffer. For a simple black-and-white system, each screen point is either on or off, so only one bit per pixel is needed to control the intensity of screen positions. A bit value of 1, for example, indicates that the electron beam is to be turned on at that position, and a value of 0 turns the beam off. Additional bits allow the intensity of the electron beam to be varied over a range of values between "on" and "off." Up to 24 bits per pixel are included in high-quality systems, which can require several megabytes of storage for the frame buffer, depending on the resolution of the system. For example, a system with 24 bits per pixel and a screen resolution of 1024 by 1024 requires 3 MB of storage for the refresh buffer. The number of bits per pixel in a frame buffer is sometimes referred to as either the **depth** of the buffer area or the number of **bit planes**. A frame buffer with one bit per pixel is commonly called a **bitmap**, and a frame buffer with multiple bits per pixel is a **pixmap**, but these terms are also used to describe other rectangular arrays, where a bitmap is any pattern of binary values and a pixmap is a multicolor pattern.

As each screen refresh takes place, we tend to see each frame as a smooth continuation of the patterns in the previous frame, so long as the refresh rate is not too low. Below about 24 frames per second, we can usually perceive a gap between successive screen images, and the picture appears to flicker. Old silent films, for example, show this effect because they were photographed at a rate of 16 frames per second. When sound systems were developed in the 1920s, motion-picture film rates increased to 24 frames per second, which removed flickering and the accompanying jerky movements of the actors. Early raster-scan computer systems were designed with a refresh rate of about 30 frames per second. This produces reasonably good results, but picture quality is improved, up to a point, with higher refresh rates on a video monitor because the display technology on the monitor is basically different from that of film. A film projector can maintain the continuous display of a film frame until the next frame is brought into view. But on a video monitor, a phosphor spot begins to decay as soon as it is illuminated. Therefore, current raster-scan displays perform refreshing at the rate of 60 to 80 frames per second, although some systems now have refresh rates of up to 120 frames per second. And some graphics systems have been designed with a variable refresh rate. For example, a higher refresh rate could be selected for a stereoscopic application so that two views of a scene (one from each eye position) can be alternately displayed without flicker. But other methods, such as multiple frame buffers, are typically used for such applications.

Sometimes, refresh rates are described in units of cycles per second, or hertz (Hz), where a cycle corresponds to one frame. Using these units, we would describe a refresh rate of 60 frames per second as simply 60 Hz. At the end of each scan line, the electron beam returns to the left side of the screen to begin displaying the next scan line. The return to the left of the screen, after refreshing

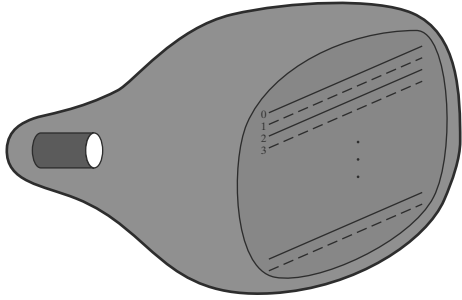

FIGURE 7

Interlacing scan lines on a raster-scan display. First, all points on the even-numbered (solid) scan lines are displayed; then all points along the odd-numbered (dashed) lines are displayed.

each scan line, is called the **horizontal retrace** of the electron beam. And at the end of each frame (displayed in $\frac{1}{80}$ to $\frac{1}{60}$ of a second), the electron beam returns to the upper-left corner of the screen (**vertical retrace**) to begin the next frame.

On some raster-scan systems and TV sets, each frame is displayed in two passes using an *interlaced* refresh procedure. In the first pass, the beam sweeps across every other scan line from top to bottom. After the vertical retrace, the beam then sweeps out the remaining scan lines (Fig. 7). Interlacing of the scan lines in this way allows us to see the entire screen displayed in half the time that it would have taken to sweep across all the lines at once from top to bottom. This technique is primarily used with slower refresh rates. On an older, 30 frame-per-second, non-interlaced display, for instance, some flicker is noticeable. But with interlacing, each of the two passes can be accomplished in $\frac{1}{60}$ of a second, which brings the refresh rate nearer to 60 frames per second. This is an effective technique for avoiding flicker—provided that adjacent scan lines contain similar display information.

Random-Scan Displays

When operated as a **random-scan display** unit, a CRT has the electron beam directed only to those parts of the screen where a picture is to be displayed. Pictures are generated as line drawings, with the electron beam tracing out the component lines one after the other. For this reason, random-scan monitors are also referred to as **vector displays** (or **stroke-writing displays** or **calligraphic displays**). The component lines of a picture can be drawn and refreshed by a random-scan system in any specified order (Fig. 8). A pen plotter operates in a similar way and is an example of a random-scan, hard-copy device.

Refresh rate on a random-scan system depends on the number of lines to be displayed on that system. Picture definition is now stored as a set of line-drawing commands in an area of memory referred to as the **display list**, **refresh display file**, **vector file**, or **display program**. To display a specified picture, the system cycles through the set of commands in the display file, drawing each component line in turn. After all line-drawing commands have been processed, the system cycles back to the first line command in the list. Random-scan displays are designed to draw all the component lines of a picture 30 to 60 times each second, with up to 100,000 “short” lines in the display list. When a small set of lines is to be displayed, each refresh cycle is delayed to avoid very high refresh rates, which could burn out the phosphor.

Random-scan systems were designed for line-drawing applications, such as architectural and engineering layouts, and they cannot display realistic shaded scenes. Since picture definition is stored as a set of line-drawing instructions rather than as a set of intensity values for all screen points, vector displays generally have higher resolutions than raster systems. Also, vector displays produce smooth line

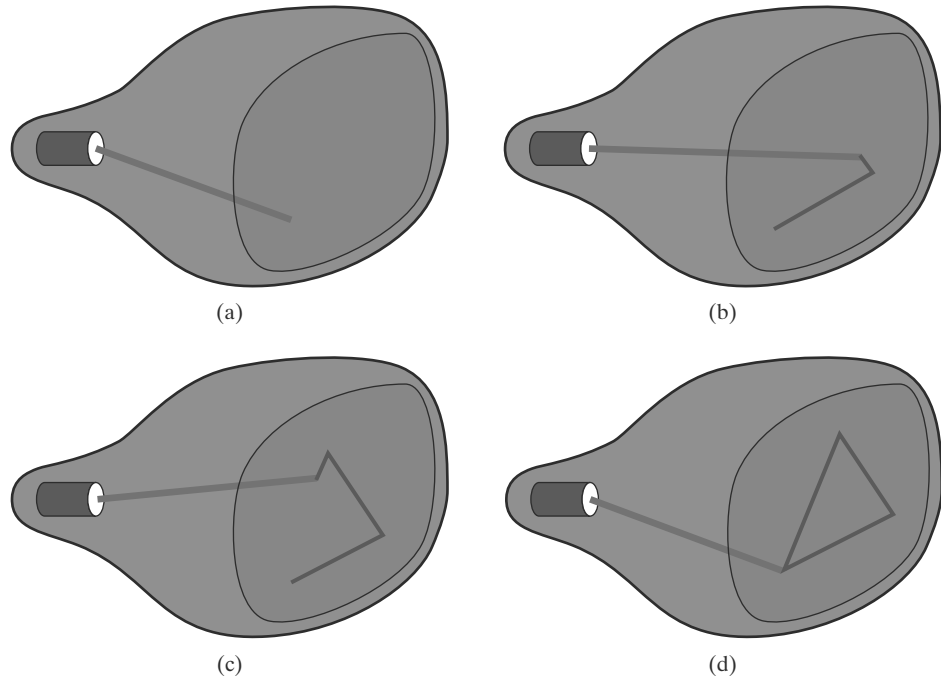

FIGURE 8
A random-scan system draws the component lines of an object in any specified order.

drawings because the CRT beam directly follows the line path. A raster system, by contrast, produces jagged lines that are plotted as discrete point sets. However, the greater flexibility and improved line-drawing capabilities of raster systems have resulted in the abandonment of vector technology.

Color CRT Monitors

A CRT monitor displays color pictures by using a combination of phosphors that emit different-colored light. The emitted light from the different phosphors merges to form a single perceived color, which depends on the particular set of phosphors that have been excited.

One way to display color pictures is to coat the screen with layers of different-colored phosphors. The emitted color depends on how far the electron beam penetrates into the phosphor layers. This approach, called the **beam-penetration** method, typically used only two phosphor layers: red and green. A beam of slow electrons excites only the outer red layer, but a beam of very fast electrons penetrates the red layer and excites the inner green layer. At intermediate beam speeds, combinations of red and green light are emitted to show two additional colors: orange and yellow. The speed of the electrons, and hence the screen color at any point, is controlled by the beam acceleration voltage. Beam penetration has been an inexpensive way to produce color, but only a limited number of colors are possible, and picture quality is not as good as with other methods.

Shadow-mask methods are commonly used in raster-scan systems (including color TV) because they produce a much wider range of colors than the beam-penetration method. This approach is based on the way that we seem to perceive colors as combinations of red, green, and blue components, called the **RGB color model**. Thus, a shadow-mask CRT uses three phosphor color dots at each pixel position. One phosphor dot emits a red light, another emits a green light, and the third emits a blue light. This type of CRT has three electron guns, one for each color dot, and a shadow-mask grid just behind the phosphor-coated screen. The

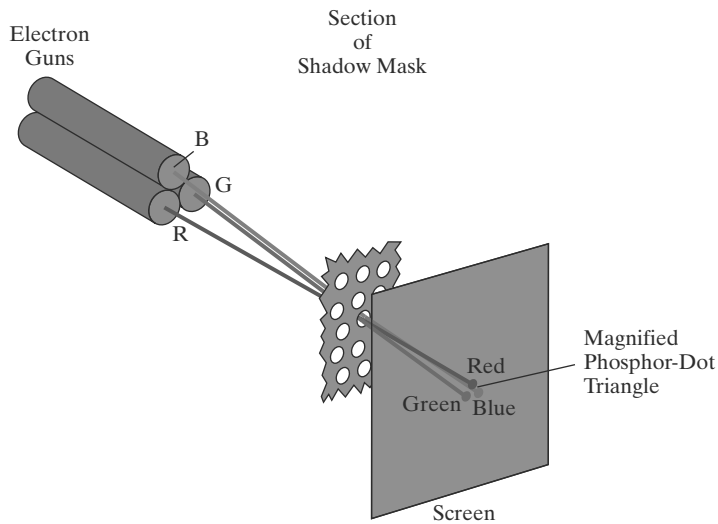

FIGURE 9
Operation of a delta-delta, shadow-mask CRT. Three electron guns, aligned with the triangular color-dot patterns on the screen, are directed to each dot triangle by a shadow mask.

light emitted from the three phosphors results in a small spot of color at each pixel position, since our eyes tend to merge the light emitted from the three dots into one composite color. Figure 9 illustrates the *delta-delta* shadow-mask method, commonly used in color CRT systems. The three electron beams are deflected and focused as a group onto the shadow mask, which contains a series of holes aligned with the phosphor-dot patterns. When the three beams pass through a hole in the shadow mask, they activate a dot triangle, which appears as a small color spot on the screen. The phosphor dots in the triangles are arranged so that each electron beam can activate only its corresponding color dot when it passes through the shadow mask. Another configuration for the three electron guns is an *in-line* arrangement in which the three electron guns, and the corresponding RGB color dots on the screen, are aligned along one scan line instead of in a triangular pattern. This in-line arrangement of electron guns is easier to keep in alignment and is commonly used in high-resolution color CRTs.

We obtain color variations in a shadow-mask CRT by varying the intensity levels of the three electron beams. By turning off two of the three guns, we get only the color coming from the single activated phosphor (red, green, or blue). When all three dots are activated with equal beam intensities, we see a white color. Yellow is produced with equal intensities from the green and red dots only, magenta is produced with equal blue and red intensities, and cyan shows up when blue and green are activated equally. In an inexpensive system, each of the three electron beams might be restricted to either on or off, limiting displays to eight colors. More sophisticated systems can allow intermediate intensity levels to be set for the electron beams, so that several million colors are possible.

Color graphics systems can be used with several types of CRT display devices. Some inexpensive home-computer systems and video games have been designed for use with a color TV set and a radio-frequency (RF) modulator. The purpose of the RF modulator is to simulate the signal from a broadcast TV station. This means that the color and intensity information of the picture must be combined and superimposed on the broadcast-frequency carrier signal that the TV requires as input. Then the circuitry in the TV takes this signal from the RF modulator, extracts the picture information, and paints it on the screen. As we might expect, this extra handling of the picture information by the RF modulator and TV circuitry decreases the quality of displayed images.

Composite monitors are adaptations of TV sets that allow bypass of the broadcast circuitry. These display devices still require that the picture information be combined, but no carrier signal is needed. Since picture information is combined into a composite signal and then separated by the monitor, the resulting picture quality is still not the best attainable.

Color CRTs in graphics systems are designed as **RGB monitors**. These monitors use shadow-mask methods and take the intensity level for each electron gun (red, green, and blue) directly from the computer system without any intermediate processing. High-quality raster-graphics systems have 24 bits per pixel in the frame buffer, allowing 256 voltage settings for each electron gun and nearly 17 million color choices for each pixel. An RGB color system with 24 bits of storage per pixel is generally referred to as a **full-color system** or a **true-color system**.

Flat-Panel Displays

Although most graphics monitors are still constructed with CRTs, other technologies are emerging that may soon replace CRT monitors. The term **flat-panel display** refers to a class of video devices that have reduced volume, weight, and power requirements compared to a CRT. A significant feature of flat-panel displays is that they are thinner than CRTs, and we can hang them on walls or wear them on our wrists. Since we can even write on some flat-panel displays, they are also available as pocket notepads. Some additional uses for flat-panel displays are as small TV monitors, calculator screens, pocket video-game screens, laptop computer screens, armrest movie-viewing stations on airlines, advertisement boards in elevators, and graphics displays in applications requiring rugged, portable monitors.

We can separate flat-panel displays into two categories: **emissive displays** and **nonemissive displays**. The emissive displays (or **emitters**) are devices that convert electrical energy into light. Plasma panels, thin-film electroluminescent displays, and light-emitting diodes are examples of emissive displays. Flat CRTs have also been devised, in which electron beams are accelerated parallel to the screen and then deflected 90° onto the screen. But flat CRTs have not proved to be as successful as other emissive devices. Nonemissive displays (or **nonemitters**) use optical effects to convert sunlight or light from some other source into graphics patterns. The most important example of a nonemissive flat-panel display is a liquid-crystal device.

Plasma panels, also called **gas-discharge displays**, are constructed by filling the region between two glass plates with a mixture of gases that usually includes neon. A series of vertical conducting ribbons is placed on one glass panel, and a set of horizontal conducting ribbons is built into the other glass panel (Fig. 10). Firing voltages applied to an intersecting pair of horizontal and vertical conductors cause the gas at the intersection of the two conductors to break down into a glowing plasma of electrons and ions. Picture definition is stored in a refresh buffer, and the firing voltages are applied to refresh the pixel positions (at the intersections of the conductors) 60 times per second. Alternating-current methods are used to provide faster application of the firing voltages and, thus, brighter displays. Separation between pixels is provided by the electric field of the conductors. One disadvantage of plasma panels has been that they were strictly monochromatic devices, but systems are now available with multicolor capabilities.

Thin-film electroluminescent displays are similar in construction to plasma panels. The difference is that the region between the glass plates is filled with a phosphor, such as zinc sulfide doped with manganese, instead of a gas (Fig. 11). When a sufficiently high voltage is applied to a pair of crossing electrodes, the

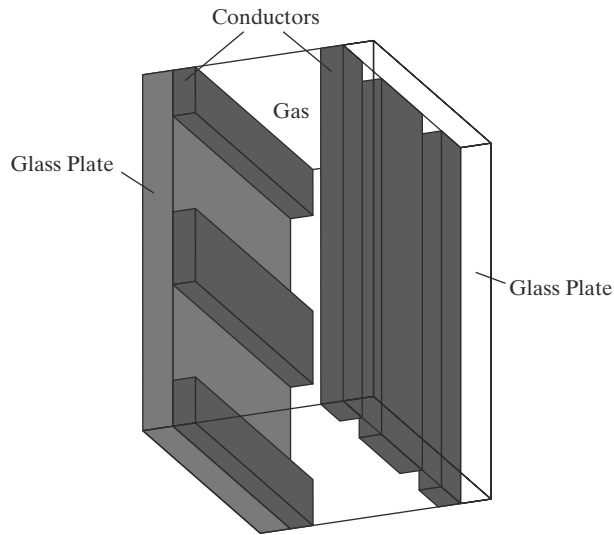

FIGURE 10
Basic design of a plasma-panel display device.

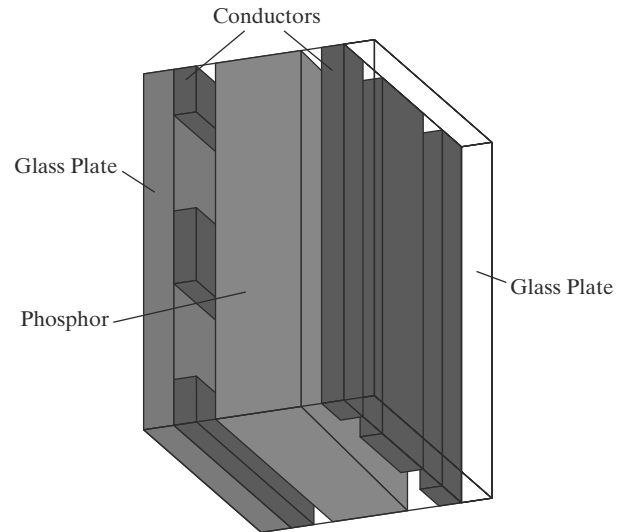

FIGURE 11
Basic design of a thin-film electroluminescent display device.

phosphor becomes a conductor in the area of the intersection of the two electrodes. Electrical energy is absorbed by the manganese atoms, which then release the energy as a spot of light similar to the glowing plasma effect in a plasma panel. Electroluminescent displays require more power than plasma panels, and good color displays are harder to achieve.

A third type of emissive device is the **light-emitting diode (LED)**. A matrix of diodes is arranged to form the pixel positions in the display, and picture definition is stored in a refresh buffer. As in scan-line refreshing of a CRT, information is read from the refresh buffer and converted to voltage levels that are applied to the diodes to produce the light patterns in the display.

Liquid-crystal displays (LCDs) are commonly used in small systems, such as laptop computers and calculators (Fig. 12). These nonemissive devices produce a picture by passing polarized light from the surroundings or from an internal light source through a liquid-crystal material that can be aligned to either block or transmit the light.

The term *liquid crystal* refers to the fact that these compounds have a crystalline arrangement of molecules, yet they flow like a liquid. Flat-panel displays commonly use nematic (threadlike) liquid-crystal compounds that tend to keep the long axes of the rod-shaped molecules aligned. A flat-panel display can then be constructed with a nematic liquid crystal, as demonstrated in Figure 13. Two glass plates, each containing a light polarizer that is aligned at a right angle to the other plate, sandwich the liquid-crystal material. Rows of horizontal, transparent conductors are built into one glass plate, and columns of vertical conductors are put into the other plate. The intersection of two conductors defines a pixel position. Normally, the molecules are aligned as shown in the “on state” of Figure 13. Polarized light passing through the material is twisted so that it will pass through the opposite polarizer. The light is then reflected back to the viewer. To turn off the pixel, we apply a voltage to the two intersecting conductors to align the molecules so that the light is not twisted. This type of flat-panel device is referred to as a **passive-matrix LCD**. Picture definitions are stored in a refresh buffer, and the screen is refreshed at the rate of 60 frames per second, as in the emissive

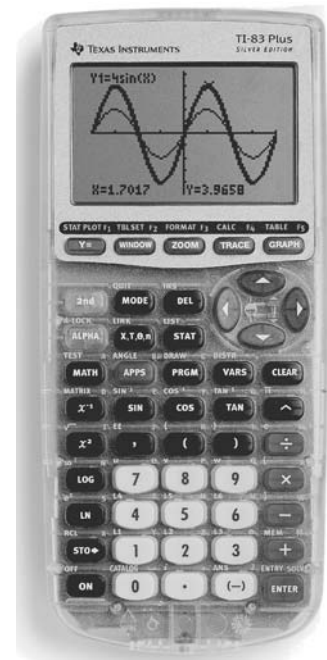

FIGURE 12
A handheld calculator with an LCD screen. (Courtesy of Texas Instruments.)

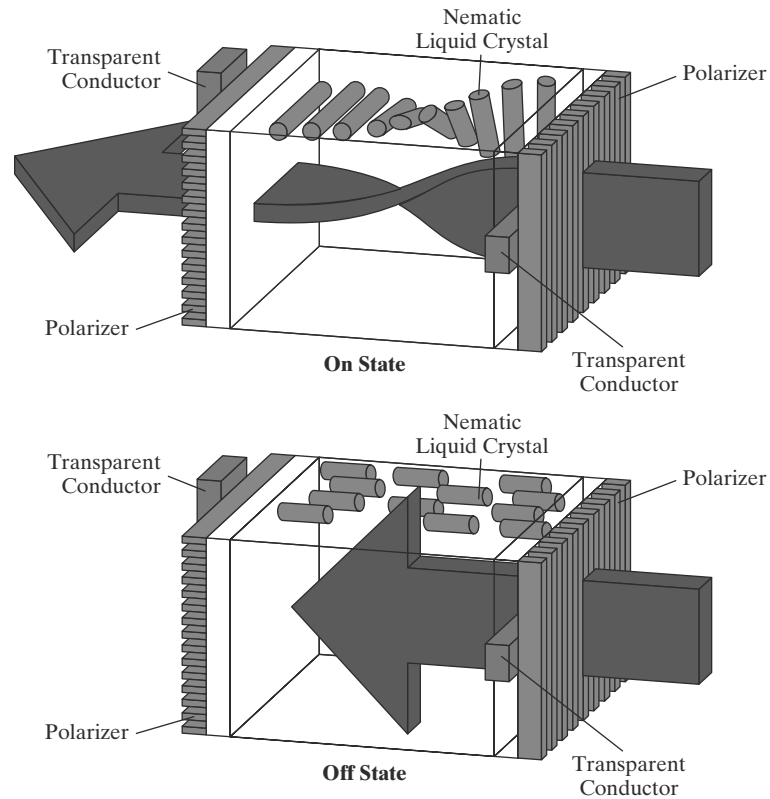

FIGURE 13
The light-twisting, shutter effect used
in the design of most LCD devices.

devices. Backlighting is also commonly applied using solid-state electronic devices, so that the system is not completely dependent on outside light sources. Colors can be displayed by using different materials or dyes and by placing a triad of color pixels at each screen location. Another method for constructing LCDs is to place a transistor at each pixel location, using thin-film transistor technology. The transistors are used to control the voltage at pixel locations and to prevent charge from gradually leaking out of the liquid-crystal cells. These devices are called **active-matrix** displays.

Three-Dimensional Viewing Devices

Graphics monitors for the display of three-dimensional scenes have been devised using a technique that reflects a CRT image from a vibrating, flexible mirror (Fig. 14). As the varifocal mirror vibrates, it changes focal length. These vibrations are synchronized with the display of an object on a CRT so that each point on the object is reflected from the mirror into a spatial position corresponding to the distance of that point from a specified viewing location. This allows us to walk around an object or scene and view it from different sides.

In addition to displaying three-dimensional images, these systems are often capable of displaying two-dimensional cross-sectional “slices” of objects selected at different depths, such as in medical applications to analyze data from ultrasonography and CAT scan devices, in geological applications to analyze topological and seismic data, in design applications involving solid objects, and in three-dimensional simulations of systems, such as molecules and terrain.

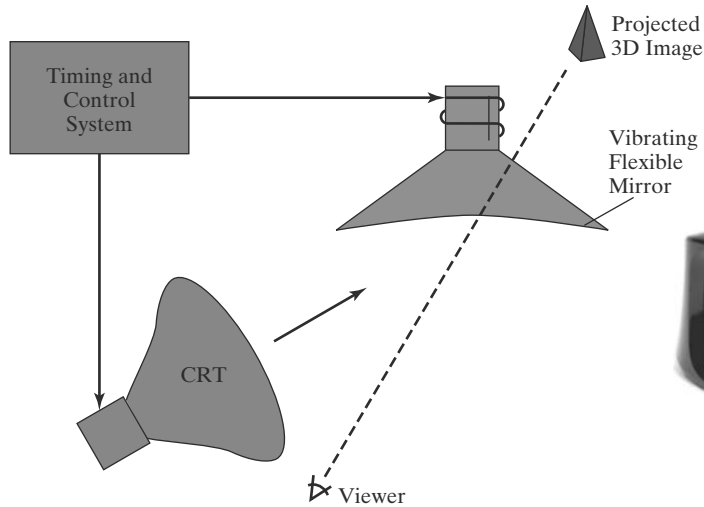

FIGURE 14
Operation of a three-dimensional display system using a vibrating mirror that changes focal length to match the depths of points in a scene.



FIGURE 15
Glasses for viewing a stereoscopic scene in 3D. (Courtesy of X-PAND, X6D USA Inc.)

Stereoscopic and Virtual-Reality Systems

Another technique for representing a three-dimensional object is to display stereoscopic views of the object. This method does not produce true three-dimensional images, but it does provide a three-dimensional effect by presenting a different view to each eye of an observer so that scenes do appear to have depth.

To obtain a stereoscopic projection, we must obtain two views of a scene generated with viewing directions along the lines from the position of each eye (left and right) to the scene. We can construct the two views as computer-generated scenes with different viewing positions, or we can use a stereo camera pair to photograph an object or scene. When we simultaneously look at the left view with the left eye and the right view with the right eye, the two views merge into a single image and we perceive a scene with depth.

One way to produce a stereoscopic effect on a raster system is to display each of the two views on alternate refresh cycles. The screen is viewed through glasses, with each lens designed to act as a rapidly alternating shutter that is synchronized to block out one of the views. One such design (Figure 15) uses liquid-crystal shutters and an infrared emitter that synchronizes the glasses with the views on the screen.

Stereoscopic viewing is also a component in **virtual-reality** systems, where users can step into a scene and interact with the environment. A headset containing an optical system to generate the stereoscopic views can be used in conjunction with interactive input devices to locate and manipulate objects in the scene. A sensing system in the headset keeps track of the viewer's position, so that the front and back of objects can be seen as the viewer "walks through" and interacts with the display. Another method for creating a virtual-reality environment

is to use projectors to generate a scene within an arrangement of walls, where a viewer interacts with a virtual display using stereoscopic glasses and data gloves (Section 4).

Lower-cost, interactive virtual-reality environments can be set up using a graphics monitor, stereoscopic glasses, and a head-tracking device. The tracking device is placed above the video monitor and is used to record head movements, so that the viewing position for a scene can be changed as head position changes.

2 Raster-Scan Systems

Interactive raster-graphics systems typically employ several processing units. In addition to the central processing unit (CPU), a special-purpose processor, called the **video controller** or **display controller**, is used to control the operation of the display device. Organization of a simple raster system is shown in Figure 16. Here, the frame buffer can be anywhere in the system memory, and the video controller accesses the frame buffer to refresh the screen. In addition to the video controller, more sophisticated raster systems employ other processors as coprocessors and accelerators to implement various graphics operations.

Video Controller

Figure 17 shows a commonly used organization for raster systems. A fixed area of the system memory is reserved for the frame buffer, and the video controller is given direct access to the frame-buffer memory.

Frame-buffer locations, and the corresponding screen positions, are referenced in Cartesian coordinates. In an application program, we use the commands

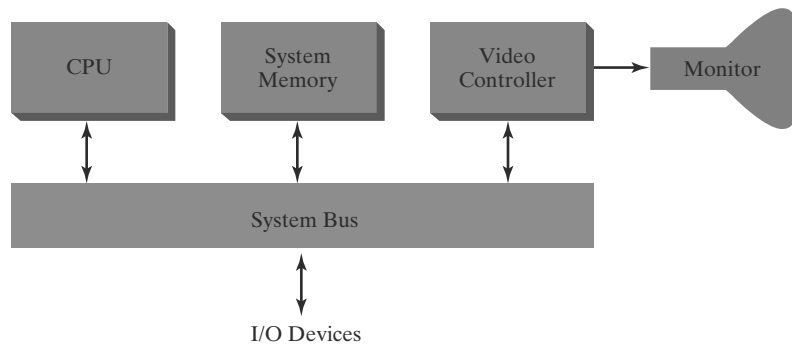

FIGURE 16
Architecture of a simple raster-graphics system.

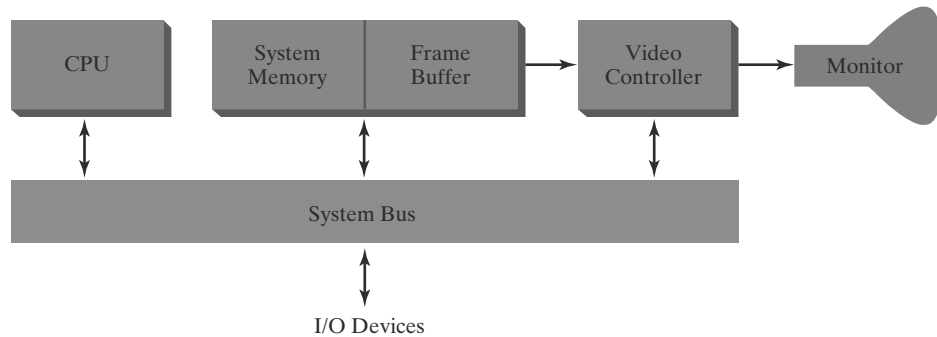

FIGURE 17
Architecture of a raster system with a fixed portion of the system memory reserved for the frame buffer.

within a graphics software package to set coordinate positions for displayed objects relative to the origin of the Cartesian reference frame. Often, the coordinate origin is referenced at the lower-left corner of a screen display area by the software commands, although we can typically set the origin at any convenient location for a particular application. Figure 18 shows a two-dimensional Cartesian reference frame with the origin at the lower-left screen corner. The screen surface is then represented as the first quadrant of a two-dimensional system, with positive x values increasing from left to right and positive y values increasing from the bottom of the screen to the top. Pixel positions are then assigned integer x values that range from 0 to x_{\max} across the screen, left to right, and integer y values that vary from 0 to y_{\max} , bottom to top. However, hardware processes such as screen refreshing, as well as some software systems, reference the pixel positions from the top-left corner of the screen.

In Figure 19, the basic refresh operations of the video controller are diagrammed. Two registers are used to store the coordinate values for the screen pixels. Initially, the x register is set to 0 and the y register is set to the value for the top scan line. The contents of the frame buffer at this pixel position are then retrieved and used to set the intensity of the CRT beam. Then the x register is incremented by 1, and the process is repeated for the next pixel on the top scan line. This procedure continues for each pixel along the top scan line. After the last pixel on the top scan line has been processed, the x register is reset to 0 and the y register is set to the value for the next scan line down from the top of the screen. Pixels along this scan line are then processed in turn, and the procedure is repeated for each successive scan line. After cycling through all pixels along the bottom scan line, the video controller resets the registers to the first pixel position on the top scan line and the refresh process starts over.

Since the screen must be refreshed at a rate of at least 60 frames per second, the simple procedure illustrated in Figure 19 may not be accommodated by typical RAM chips if the cycle time is too slow. To speed up pixel processing,

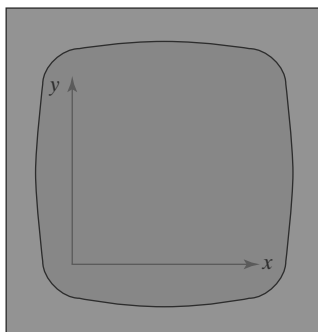

FIGURE 18
A Cartesian reference frame with origin at the lower-left corner of a video monitor.

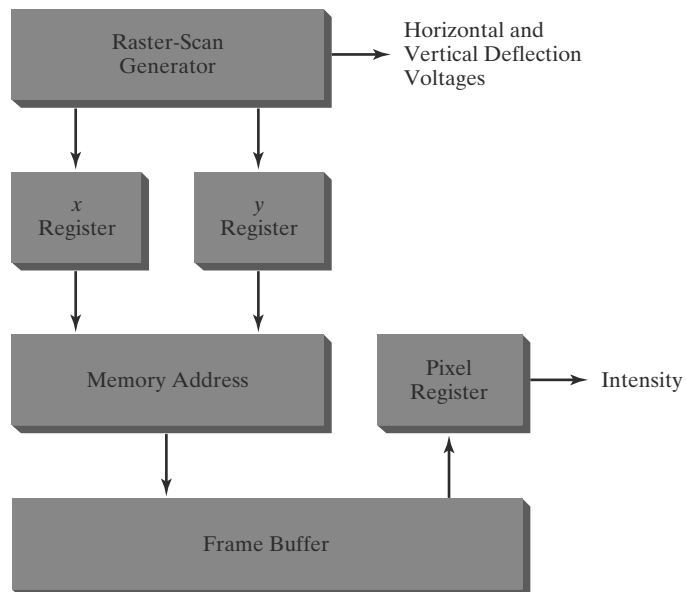

FIGURE 19
Basic video-controller refresh operations.

video controllers can retrieve multiple pixel values from the refresh buffer on each pass. The multiple pixel intensities are then stored in a separate register and used to control the CRT beam intensity for a group of adjacent pixels. When that group of pixels has been processed, the next block of pixel values is retrieved from the frame buffer.

A video controller can be designed to perform a number of other operations. For various applications, the video controller can retrieve pixel values from different memory areas on different refresh cycles. In some systems, for example, multiple frame buffers are often provided so that one buffer can be used for refreshing while pixel values are being loaded into the other buffers. Then the current refresh buffer can switch roles with one of the other buffers. This provides a fast mechanism for generating real-time animations, for example, since different views of moving objects can be successively loaded into a buffer without interrupting a refresh cycle. Another video-controller task is the transformation of blocks of pixels, so that screen areas can be enlarged, reduced, or moved from one location to another during the refresh cycles. In addition, the video controller often contains a lookup table, so that pixel values in the frame buffer are used to access the lookup table instead of controlling the CRT beam intensity directly. This provides a fast method for changing screen intensity values. Finally, some systems are designed to allow the video controller to mix the frame-buffer image with an input image from a television camera or other input device.

Raster-Scan Display Processor

Figure 20 shows one way to organize the components of a raster system that contains a separate **display processor**, sometimes referred to as a **graphics controller** or a **display coprocessor**. The purpose of the display processor is to free the CPU from the graphics chores. In addition to the system memory, a separate display-processor memory area can be provided.

A major task of the display processor is digitizing a picture definition given in an application program into a set of pixel values for storage in the frame buffer. This digitization process is called **scan conversion**. Graphics commands specifying straight lines and other geometric objects are scan converted into a set of discrete points, corresponding to screen pixel positions. Scan converting a straight-line segment, for example, means that we have to locate the pixel positions closest to the line path and store the color for each position in the frame

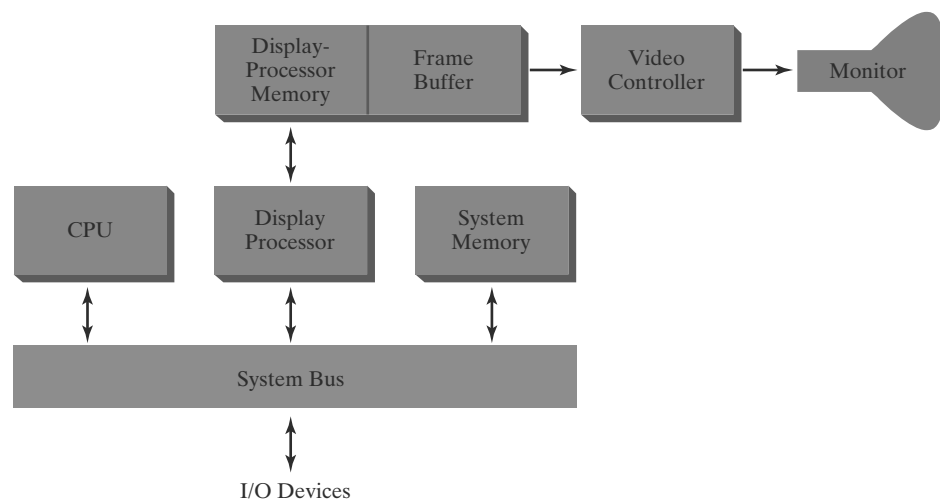

FIGURE 20
Architecture of a raster-graphics system with a display processor.

buffer. Similar methods are used for scan converting other objects in a picture definition. Characters can be defined with rectangular pixel grids, as in Figure 21, or they can be defined with outline shapes, as in Figure 22. The array size for character grids can vary from about 5 by 7 to 9 by 12 or more for higher-quality displays. A character grid is displayed by superimposing the rectangular grid pattern into the frame buffer at a specified coordinate position. For characters that are defined as outlines, the shapes are scan-converted into the frame buffer by locating the pixel positions closest to the outline.

Display processors are also designed to perform a number of additional operations. These functions include generating various line styles (dashed, dotted, or solid), displaying color areas, and applying transformations to the objects in a scene. Also, display processors are typically designed to interface with interactive input devices, such as a mouse.

In an effort to reduce memory requirements in raster systems, methods have been devised for organizing the frame buffer as a linked list and encoding the color information. One organization scheme is to store each scan line as a set of number pairs. The first number in each pair can be a reference to a color value, and the second number can specify the number of adjacent pixels on the scan line that are to be displayed in that color. This technique, called **run-length encoding**, can result in a considerable saving in storage space if a picture is to be constructed mostly with long runs of a single color each. A similar approach can be taken when pixel colors change linearly. Another approach is to encode the raster as a set of rectangular areas (**cell encoding**). The disadvantages of encoding runs are that color changes are difficult to record and storage requirements increase as the lengths of the runs decrease. In addition, it is difficult for the display controller to process the raster when many short runs are involved. Moreover, the size of the frame buffer is no longer a major concern, because of sharp declines in memory costs. Nevertheless, encoding methods can be useful in the digital storage and transmission of picture information.

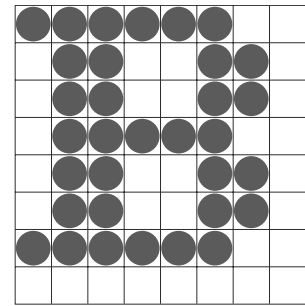

FIGURE 21
A character defined as a rectangular grid of pixel positions.

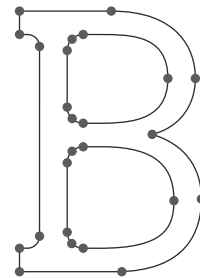

FIGURE 22
A character defined as an outline shape.

3 Graphics Workstations and Viewing Systems

Most graphics monitors today operate as raster-scan displays, and both CRT and flat-panel systems are in common use. Graphics workstations range from small general-purpose computer systems to multi-monitor facilities, often with ultra-large viewing screens. For a personal computer, screen resolutions vary from about 640 by 480 to 1280 by 1024, and diagonal screen lengths measure from 12 inches to over 21 inches. Most general-purpose systems now have considerable color capabilities, and many are full-color systems. For a desktop workstation specifically designed for graphics applications, the screen resolution can vary from 1280 by 1024 to about 1600 by 1200, with a typical screen diagonal of 18 inches or more. Commercial workstations can also be obtained with a variety of devices for specific applications.

High-definition graphics systems, with resolutions up to 2560 by 2048, are commonly used in medical imaging, air-traffic control, simulation, and CAD. Many high-end graphics workstations also include large viewing screens, often with specialized features.

Multi-panel display screens are used in a variety of applications that require “wall-sized” viewing areas. These systems are designed for presenting graphics displays at meetings, conferences, conventions, trade shows, retail stores, museums, and passenger terminals. A multi-panel display can be used to show a large

view of a single scene or several individual images. Each panel in the system displays one section of the overall picture. Color Plate 7 shows a 360° paneled viewing system in the NASA control-tower simulator, which is used for training and for testing ways to solve air-traffic and runway problems at airports. Large graphics displays can also be presented on curved viewing screens. A large, curved-screen system can be useful for viewing by a group of people studying a particular graphics application, such as the example in Color Plate 8. A control center, featuring a battery of standard monitors, allows an operator to view sections of the large display and to control the audio, video, lighting, and projection systems using a touch-screen menu. The system projectors provide a seamless, multichannel display that includes edge blending, distortion correction, and color balancing. And a surround-sound system is used to provide the audio environment.

4 Input Devices

Graphics workstations can make use of various devices for data input. Most systems have a keyboard and one or more additional devices specifically designed for interactive input. These include a mouse, trackball, spaceball, and joystick. Some other input devices used in particular applications are digitizers, dials, button boxes, data gloves, touch panels, image scanners, and voice systems.

Keyboards, Button Boxes, and Dials

An alphanumeric **keyboard** on a graphics system is used primarily as a device for entering text strings, issuing certain commands, and selecting menu options. The keyboard is an efficient device for inputting such nongraphic data as picture labels associated with a graphics display. Keyboards can also be provided with features to facilitate entry of screen coordinates, menu selections, or graphics functions.

Cursor-control keys and function keys are common features on general-purpose keyboards. Function keys allow users to select frequently accessed operations with a single keystroke, and cursor-control keys are convenient for selecting a displayed object or a location by positioning the screen cursor. A keyboard can also contain other types of cursor-positioning devices, such as a trackball or joystick, along with a numeric keypad for fast entry of numeric data. In addition to these features, some keyboards have an ergonomic design that provides adjustments for relieving operator fatigue.

For specialized tasks, input to a graphics application may come from a set of buttons, dials, or switches that select data values or customized graphics operations. Buttons and switches are often used to input predefined functions, and dials are common devices for entering scalar values. Numerical values within some defined range are selected for input with dial rotations. A potentiometer is used to measure dial rotation, which is then converted to the corresponding numerical value.

Mouse Devices

A **mouse** is a small handheld unit that is usually moved around on a flat surface to position the screen cursor. One or more buttons on the top of the mouse provide a mechanism for communicating selection information to the computer; wheels or rollers on the bottom of the mouse can be used to record the amount and direction of movement. Another method for detecting mouse motion is with an optical sensor. For some optical systems, the mouse is moved over a special mouse pad that has a grid of horizontal and vertical lines. The optical sensor detects

**FIGURE 23**

A wireless computer mouse designed with many user-programmable controls.
(Courtesy of Logitech®)

movement across the lines in the grid. Other optical mouse systems can operate on any surface. Some mouse systems are cordless, communicating with computer processors using digital radio technology.

Since a mouse can be picked up and put down at another position without change in cursor movement, it is used for making relative changes in the position of the screen cursor. One, two, three, or four buttons are included on the top of the mouse for signaling the execution of operations, such as recording cursor position or invoking a function. Most general-purpose graphics systems now include a mouse and a keyboard as the primary input devices.

Additional features can be included in the basic mouse design to increase the number of allowable input parameters and the functionality of the mouse. The Logitech G700 wireless gaming mouse in Figure 23 features 13 separately-programmable control inputs. Each input can be configured to perform a wide range of actions, from traditional single-click inputs to macro operations containing multiple keystrokes, mouse events, and pre-programmed delays between operations. The laser-based optical sensor can be configured to control the degree of sensitivity to motion, allowing the mouse to be used in situations requiring different levels of control over cursor movement. In addition, the mouse can hold up to five different configuration profiles to allow the configuration to be switched easily when changing applications.

Trackballs and Spaceballs

A **trackball** is a ball device that can be rotated with the fingers or palm of the hand to produce screen-cursor movement. Potentiometers, connected to the ball, measure the amount and direction of rotation. Laptop keyboards are often equipped with a trackball to eliminate the extra space required by a mouse. A trackball also can be mounted on other devices, or it can be obtained as a separate add-on unit that contains two or three control buttons.

An extension of the two-dimensional trackball concept is the **spaceball**, which provides six degrees of freedom. Unlike the trackball, a spaceball does not actually move. Strain gauges measure the amount of pressure applied to the spaceball to provide input for spatial positioning and orientation as the ball is pushed or pulled in various directions. Spaceballs are used for three-dimensional positioning and selection operations in virtual-reality systems, modeling, animation, CAD, and other applications.

Joysticks

Another positioning device is the **joystick**, which consists of a small, vertical lever (called the stick) mounted on a base. We use the joystick to steer the screen cursor around. Most joysticks select screen positions with actual stick movement; others

respond to pressure on the stick. Some joysticks are mounted on a keyboard, and some are designed as stand-alone units.

The distance that the stick is moved in any direction from its center position corresponds to the relative screen-cursor movement in that direction. Potentiometers mounted at the base of the joystick measure the amount of movement, and springs return the stick to the center position when it is released. One or more buttons can be programmed to act as input switches to signal actions that are to be executed once a screen position has been selected.

In another type of movable joystick, the stick is used to activate switches that cause the screen cursor to move at a constant rate in the direction selected. Eight switches, arranged in a circle, are sometimes provided so that the stick can select any one of eight directions for cursor movement. Pressure-sensitive joysticks, also called *isometric joysticks*, have a non-movable stick. A push or pull on the stick is measured with strain gauges and converted to movement of the screen cursor in the direction of the applied pressure.

Data Gloves

A **data glove** is a device that fits over the user's hand and can be used to grasp a "virtual object." The glove is constructed with a series of sensors that detect hand and finger motions. Electromagnetic coupling between transmitting antennas and receiving antennas are used to provide information about the position and orientation of the hand. The transmitting and receiving antennas can each be structured as a set of three mutually perpendicular coils, forming a three-dimensional Cartesian reference system. Input from the glove is used to position or manipulate objects in a virtual scene. A two-dimensional projection of the scene can be viewed on a video monitor, or a three-dimensional projection can be viewed with a headset.

Digitizers

A common device for drawing, painting, or interactively selecting positions is a **digitizer**. These devices can be designed to input coordinate values in either a two-dimensional or a three-dimensional space. In engineering or architectural applications, a digitizer is often used to scan a drawing or object and to input a set of discrete coordinate positions. The input positions are then joined with straight-line segments to generate an approximation of a curve or surface shape.

One type of digitizer is the **graphics tablet** (also referred to as a *data tablet*), which is used to input two-dimensional coordinates by activating a hand cursor or stylus at selected positions on a flat surface. A hand cursor contains crosshairs for sighting positions, while a stylus is a pencil-shaped device that is pointed at positions on the tablet. The tablet size varies from 12 by 12 inches for desktop models to 44 by 60 inches or larger for floor models. Graphics tablets provide a highly accurate method for selecting coordinate positions, with an accuracy that varies from about 0.2 mm on desktop models to about 0.05 mm or less on larger models.

Many graphics tablets are constructed with a rectangular grid of wires embedded in the tablet surface. Electromagnetic pulses are generated in sequence along the wires, and an electric signal is induced in a wire coil in an activated stylus or hand-cursor to record a tablet position. Depending on the technology, signal strength, coded pulses, or phase shifts can be used to determine the position on the tablet.

An *acoustic* (or *sonic*) *tablet* uses sound waves to detect a stylus position. Either strip microphones or point microphones can be employed to detect the sound

emitted by an electrical spark from a stylus tip. The position of the stylus is calculated by timing the arrival of the generated sound at the different microphone positions. An advantage of two-dimensional acoustic tablets is that the microphones can be placed on any surface to form the “tablet” work area. For example, the microphones could be placed on a book page while a figure on that page is digitized.

Three-dimensional digitizers use sonic or electromagnetic transmissions to record positions. One electromagnetic transmission method is similar to that employed in the data glove: A coupling between the transmitter and receiver is used to compute the location of a stylus as it moves over an object surface. As the points are selected on a nonmetallic object, a wire-frame outline of the surface is displayed on the computer screen. Once the surface outline is constructed, it can be rendered using lighting effects to produce a realistic display of the object.

Image Scanners

Drawings, graphs, photographs, or text can be stored for computer processing with an **image scanner** by passing an optical scanning mechanism over the information to be stored. The gradations of grayscale or color are then recorded and stored in an array. Once we have the internal representation of a picture, we can apply transformations to rotate, scale, or crop the picture to a particular screen area. We can also apply various image-processing methods to modify the array representation of the picture. For scanned text input, various editing operations can be performed on the stored documents. Scanners are available in a variety of sizes and capabilities, including small handheld models, drum scanners, and flatbed scanners.

Touch Panels

As the name implies, **touch panels** allow displayed objects or screen positions to be selected with the touch of a finger. A typical application of touch panels is for the selection of processing options that are represented as a menu of graphical icons. Some monitors are designed with touch screens. Other systems can be adapted for touch input by fitting a transparent device containing a touch-sensing mechanism over the video monitor screen. Touch input can be recorded using optical, electrical, or acoustical methods.

Optical touch panels employ a line of infrared light-emitting diodes (LEDs) along one vertical edge and along one horizontal edge of the frame. Light detectors are placed along the opposite vertical and horizontal edges. These detectors are used to record which beams are interrupted when the panel is touched. The two crossing beams that are interrupted identify the horizontal and vertical coordinates of the screen position selected. Positions can be selected with an accuracy of about 1/4 inch. With closely spaced LEDs, it is possible to break two horizontal or two vertical beams simultaneously. In this case, an average position between the two interrupted beams is recorded. The LEDs operate at infrared frequencies so that the light is not visible to a user.

An electrical touch panel is constructed with two transparent plates separated by a small distance. One of the plates is coated with a conducting material, and the other plate is coated with a resistive material. When the outer plate is touched, it is forced into contact with the inner plate. This contact creates a voltage drop across the resistive plate that is converted to the coordinate values of the selected screen position.

In acoustical touch panels, high-frequency sound waves are generated in horizontal and vertical directions across a glass plate. Touching the screen causes

part of each wave to be reflected from the finger to the emitters. The screen position at the point of contact is calculated from a measurement of the time interval between the transmission of each wave and its reflection to the emitter.

Light Pens

Light pens are pencil-shaped devices used to select screen positions by detecting the light coming from points on the CRT screen. They are sensitive to the short burst of light emitted from the phosphor coating at the instant the electron beam strikes a particular point. Other light sources, such as the background light in the room, are usually not detected by a light pen. An activated light pen, pointed at a spot on the screen as the electron beam lights up that spot, generates an electrical pulse that causes the coordinate position of the electron beam to be recorded. As with cursor-positioning devices, recorded light-pen coordinates can be used to position an object or to select a processing option.

Although light pens are still with us, they are not as popular as they once were because they have several disadvantages compared to other input devices that have been developed. For example, when a light pen is pointed at the screen, part of the screen image is obscured by the hand and pen. In addition, prolonged use of the light pen can cause arm fatigue, and light pens require special implementations for some applications because they cannot detect positions within black areas. To be able to select positions in any screen area with a light pen, we must have some nonzero light intensity emitted from each pixel within that area. In addition, light pens sometimes give false readings due to background lighting in a room.

Voice Systems

Speech recognizers are used with some graphics workstations as input devices for voice commands. The **voice system** input can be used to initiate graphics operations or to enter data. These systems operate by matching an input against a predefined dictionary of words and phrases.

A dictionary is set up by speaking the command words several times. The system then analyzes each word and establishes a dictionary of word frequency patterns, along with the corresponding functions that are to be performed. Later, when a voice command is given, the system searches the dictionary for a frequency-pattern match. A separate dictionary is needed for each operator using the system. Input for a voice system is typically spoken into a microphone mounted on a headset; the microphone is designed to minimize input of background sounds. Voice systems have some advantage over other input devices because the attention of the operator need not switch from one device to another to enter a command.

5 Hard-Copy Devices

We can obtain hard-copy output for our images in several formats. For presentations or archiving, we can send image files to devices or service bureaus that will produce overhead transparencies, 35mm slides, or film. Also, we can put our pictures on paper by directing graphics output to a printer or plotter.

The quality of the pictures obtained from an output device depends on dot size and the number of dots per inch, or lines per inch, that can be displayed. To produce smooth patterns, higher-quality printers shift dot positions so that adjacent dots overlap.

**FIGURE 24**

A picture generated on a dot-matrix printer, illustrating how the density of dot patterns can be varied to produce light and dark areas. (Courtesy of Apple Computer, Inc.)

Printers produce output by either impact or nonimpact methods. *Impact* printers press formed character faces against an inked ribbon onto the paper. A line printer is an example of an impact device, with the typefaces mounted on bands, chains, drums, or wheels. *Nonimpact* printers and plotters use laser techniques, ink-jet sprays, electrostatic methods, and electrothermal methods to get images onto paper.

Character impact printers often have a *dot-matrix* print head containing a rectangular array of protruding wire pins, with the number of pins varying depending upon the quality of the printer. Individual characters or graphics patterns are obtained by retracting certain pins so that the remaining pins form the pattern to be printed. Figure 24 shows a picture printed on a dot-matrix printer.

In a *laser* device, a laser beam creates a charge distribution on a rotating drum coated with a photoelectric material, such as selenium. Toner is applied to the drum and then transferred to paper. *Ink-jet* methods produce output by squirting ink in horizontal rows across a roll of paper wrapped on a drum. The electrically charged ink stream is deflected by an electric field to produce dot-matrix patterns. An *electrostatic* device places a negative charge on the paper, one complete row at a time across the sheet. Then the paper is exposed to a positively charged toner. This causes the toner to be attracted to the negatively charged areas, where it adheres to produce the specified output. Another output technology is the *electrothermal* printer. With these systems, heat is applied to a dot-matrix print head to output patterns on heat-sensitive paper.

We can get limited color output on some impact printers by using different-colored ribbons. Nonimpact devices use various techniques to combine three different color pigments (cyan, magenta, and yellow) to produce a range of color patterns. Laser and electrostatic devices deposit the three pigments on separate passes; ink-jet methods shoot the three colors simultaneously on a single pass along each print line.

Drafting layouts and other drawings are typically generated with ink-jet or pen plotters. A pen plotter has one or more pens mounted on a carriage, or crossbar, that spans a sheet of paper. Pens with varying colors and widths are used to produce a variety of shadings and line styles. Wet-ink, ballpoint, and felt-tip pens are all possible choices for use with a pen plotter. Plotter paper can lie flat or it can be rolled onto a drum or belt. Crossbars can be either movable or stationary, while the pen moves back and forth along the bar. The paper is held in position using clamps, a vacuum, or an electrostatic charge.

6 Graphics Networks

So far, we have mainly considered graphics applications on an isolated system with a single user. However, multiuser environments and computer networks are now common elements in many graphics applications. Various resources, such as processors, printers, plotters, and data files, can be distributed on a network and shared by multiple users.

A graphics monitor on a network is generally referred to as a **graphics server**, or simply a **server**. Often, the monitor includes standard input devices such as a keyboard and a mouse or trackball. In that case, the system can provide input, as well as being an output server. The computer on the network that is executing a graphics application program is called the **client**, and the output of the program is displayed on a server. A workstation that includes processors, as well as a monitor and input devices, can function as both a server and a client.

When operating on a network, a client computer transmits the instructions for displaying a picture to the monitor (server). Typically, this is accomplished by collecting the instructions into packets before transmission instead of sending the individual graphics instructions one at a time over the network. Thus, graphics software packages often contain commands that affect packet transmission, as well as the commands for creating pictures.

7 Graphics on the Internet

A great deal of graphics development is now done on the global collection of computer networks known as the **Internet**. Computers on the Internet communicate using *transmission control protocol/internet protocol* (TCP/IP). In addition, the **World Wide Web** provides a hypertext system that allows users to locate and view documents that can contain text, graphics, and audio. Resources, such as graphics files, are identified by a *uniform (or universal) resource locator* (URL). Each URL contains two parts: (1) the protocol for transferring the document, and (2) the server that contains the document and, optionally, the location (directory) on the server. For example, the URL *http://www.siggraph.org/* indicates a document that is to be transferred with the *hypertext transfer protocol* (*http*) and that the server is *www.siggraph.org*, which is the home page of the Special Interest Group in Graphics (SIGGRAPH) of the Association for Computing Machinery. Another common type of URL begins with *ftp://*. This identifies a site that accepts *file transfer protocol* (FTP) connections, through which programs or other files can be downloaded.

Documents on the Internet can be constructed with the *Hypertext Markup Language* (HTML). The development of HTML provided a simple method for describing a document containing text, graphics, and references (hyperlinks) to other documents. Although resources could be made available using HTML and URL addressing, it was difficult originally to find information on the Internet. Subsequently, the National Center for Supercomputing Applications (NCSA) developed a "browser" called Mosaic, which made it easier for users to search for Web resources. The Mosaic browser later evolved into the browser called Netscape Navigator. In turn, Netscape Navigator inspired the creation of the Mozilla family of browsers, whose most well-known member is, perhaps, Firefox.

HTML provides a simple method for developing graphics on the Internet, but it has limited capabilities. Therefore, other languages have been developed for Internet graphics applications.

8 Summary

In this chapter, we surveyed the major hardware and software features of computer-graphics systems. Hardware components include video monitors, hardcopy output devices, various kinds of input devices, and components for interacting with virtual environments.

The predominant graphics display device is the raster refresh monitor, based on television technology. A raster system uses a frame buffer to store the color value for each screen position (pixel). Pictures are then painted onto the screen by retrieving this information from the frame buffer (also called a *refresh buffer*) as the electron beam in the CRT sweeps across each scan line from top to bottom. Older vector displays construct pictures by drawing straight-line segments between specified endpoint positions. Picture information is then stored as a set of line-drawing instructions.

Many other video display devices are available. In particular, flat-panel display technology is developing at a rapid rate, and these devices are now used in a variety of systems, including both desktop and laptop computers. Plasma panels and liquid-crystal devices are two examples of flat-panel displays. Other display technologies include three-dimensional and stereoscopic-viewing systems. Virtual-reality systems can include either a stereoscopic headset or a standard video monitor.

For graphical input, we have a range of devices to choose from. Keyboards, button boxes, and dials are used to input text, data values, or programming options. The most popular “pointing” device is the mouse, but trackballs, spaceballs, joysticks, cursor-control keys, and thumbwheels are also used to position the screen cursor. In virtual-reality environments, data gloves are commonly used. Other input devices are image scanners, digitizers, touch panels, light pens, and voice systems.

Hardcopy devices for graphics workstations include standard printers and plotters, in addition to devices for producing slides, transparencies, and film output. Printers produce hardcopy output using dot-matrix, laser, ink-jet, electrostatic, or electrothermal methods. Graphs and charts can be produced with an ink-pen plotter or with a combination printer-plotter device.

REFERENCES

A general treatment of electronic displays is available in Tannas (1985) and in Sherr (1993). Flat-panel devices are discussed in Depp and Howard (1993). Additional information on raster-graphics architecture can be found in Foley et al. (1990). Three-dimensional and stereoscopic displays are discussed in Johnson (1982) and in Grotch (1983). Head-mounted displays and virtual-reality environments are discussed in Chung et al. (1989).

EXERCISES

- 1 List the operating characteristics for the following display technologies: raster refresh systems, vector refresh systems, plasma panels, and LCDs.
- 2 List some applications appropriate for each of the display technologies in the previous question.
- 3 Determine the resolution (pixels per centimeter) in the x and y directions for the video monitor in use on your system. Determine the aspect ratio, and explain how relative proportions of objects can be maintained on your system.
- 4 Consider three different raster systems with resolutions of 800 by 600, 1280 by 960, and 1680 by 1050. What size frame buffer (in bytes) is needed for each of these systems to store 16 bits per pixel? How much storage is required for each system if 32 bits per pixel are to be stored?
- 5 Suppose an RGB raster system is to be designed using an 8 inch by 10 inch screen with a resolution of 100 pixels per inch in each direction. If we want to store 6 bits per pixel in the frame buffer, how much storage (in bytes) do we need for the frame buffer?
- 6 How long would it take to load an 800 by 600 frame buffer with 16 bits per pixel, if 105 bits can be transferred per second? How long would it take to